

Thermo Scientific Heracell VIOS
CO₂ Incubator



Designed to achieve
your next breakthrough

Designed to achieve your next breakthrough

The **Thermo Scientific™ Heracell™ VIOS series** represents a new era in advanced incubator design for sensitive cultures like stem and primary cells in leading research, pharmaceutical and clinical laboratory applications.

Through a holistic approach to culturing, our newest incubator series provides everything necessary for your most demanding and highly critical applications. By combining our latest technology advancements in contamination control and uniform growth conditions with existing proven and reliable features, you are now able to achieve your goals faster, more reliably, and with less effort.

Better solutions for optimal cell growth

Revolutionary THRIVE™ active airflow technology delivers homogeneous growth conditions fast, avoiding unwanted sample variation.

Complete contamination control

Proven protection from every direction including ISO class 5 HEPA filtered air, on-demand high-temperature sterilization, and easy to maintain copper.

Enhanced simplicity

Designed to focus on convenience, allowing you to spend more time on your research and less time managing your incubator.

The Heracell VIOS CO₂ incubator delivers the performance reliability, ease of operation, and value required to support a range of culturing needs from basic research to demanding, leading-edge applications, so you're ready for whatever comes next!



A direct heat CO₂ incubator that better supports you and your science.



- 165L (5.8 cu ft) in a compact foot print, readily stackable
- Choice of electropolished stainless steel or 100% pure copper
- Adjustable, perforated shelving
- Easy-to-clean, coved corners with convenient access port
- Reversible exterior door for added flexibility
- 2 year parts and labor warranty

Better solutions for optimal cell growth

The Heracell VIOS incubator incorporates THRIVE active airflow technology, providing faster recovery and uniformity for consistent results. Your cells experience total recovery of all critical growth parameters in **less than 10 minutes following a door opening.***

**Innovative
THRIVE
active airflow
technology**

In-chamber fan gently and evenly distributes clean, humidified air throughout the chamber ensuring all cells experience the same conditions without the threat of desiccation.

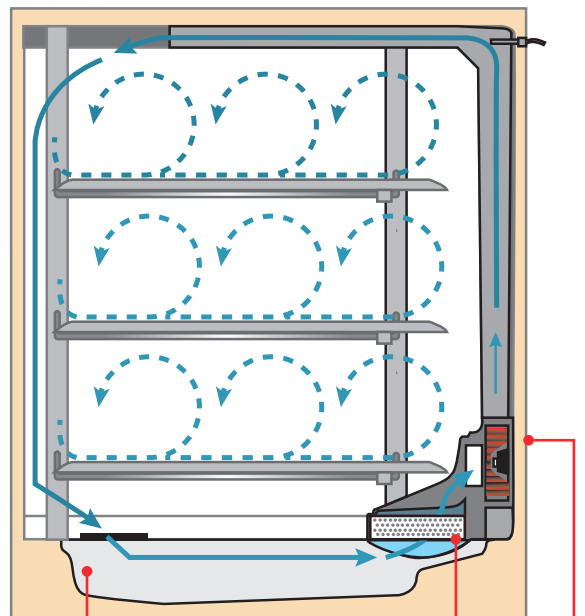

Incoming air first travels over a direct heated water reservoir resulting in 50% faster humidity recovery than with a standard water pan design.**

The in-line HEPA filter cleans the airstream of microbes and particles protecting cultures from contamination.

The precise, variable speed fan with an auto-stop function disables fan operation during door openings to minimize air exchange. Once the door is closed, the fan temporarily accelerates for quick recovery.

* Based on internal testing standards for a 30 second door opening, recovery time calculated to 98% of starting value for temperature and CO₂ and 95% of starting value for humidity

**Comparison of internal testing data to published specifications

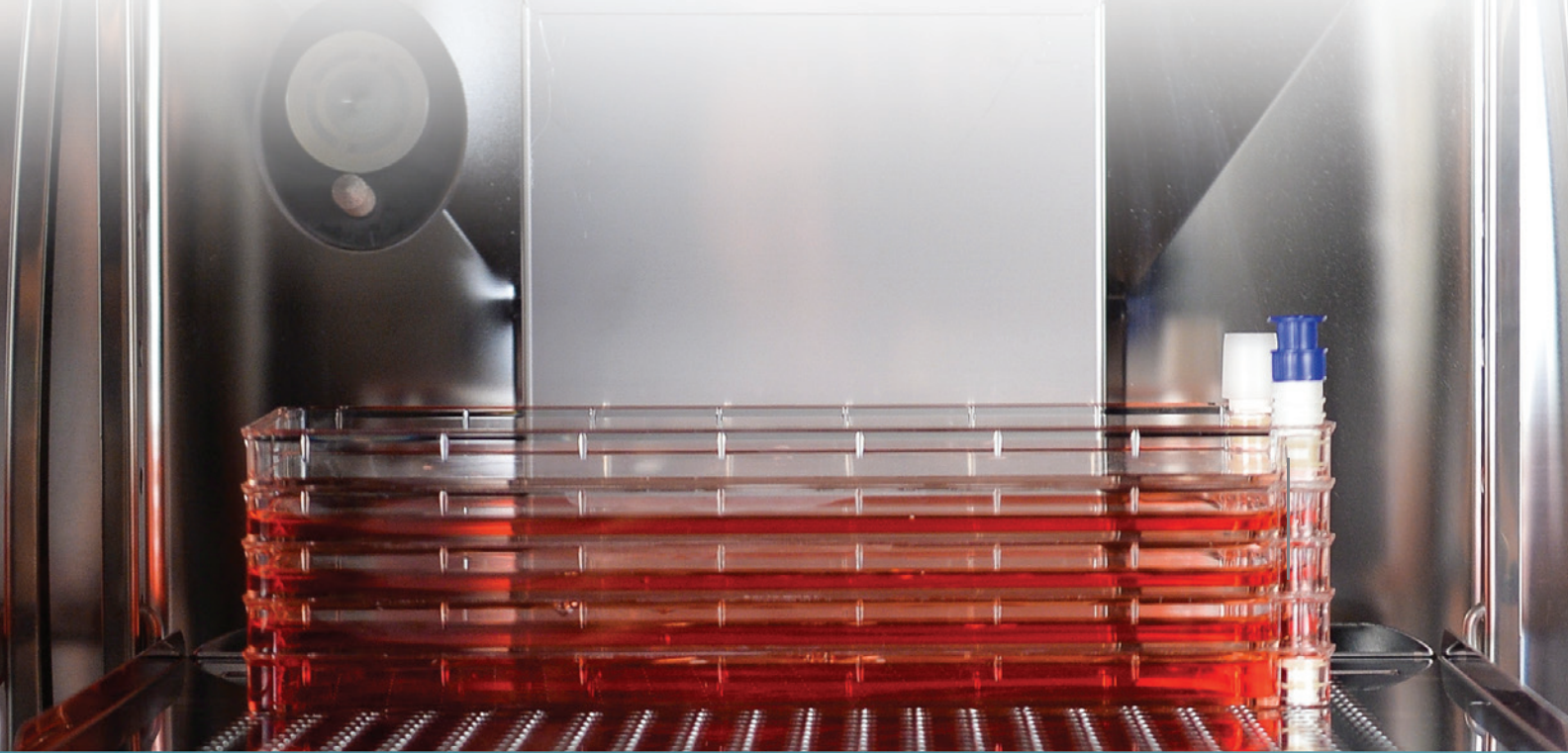

| optimal cell growth



Advanced *in situ* sensor technology

Probes and gas sensors are positioned in the chamber to respond quickly to any deviations in desired conditions

- Robust design allows maintenance-free, *in situ* location, eliminating the need for removal during sterilization and separate cleaning and handling activities
- **New!** Dual temperature probes with PID controller provide over temperature protection by preventing overshoot during recovery; temperatures recover under 5 minutes*
- Oxygen controlled models are equipped with advanced zirconium oxide sensors, enabling a choice of control ranges 1-21% (hypoxic) and 5-90% (hyperoxic)
- On-demand auto-start facilitates easy start-up and calibration

▶ Save valuable incubator space with Thermo Scientific Nunc EasyFill Cell Factory systems.
www.thermoscientific.com/easyfill

* Temperature recovery time calculated to 98% of starting value, based on internal testing standards of a 30 second door opening

Choice of accurate and reliable CO₂ sensor technology

Temperature resistant, bulb-free IR CO₂ sensor with MEMS emitter technology

New temperature resistant IR180Si infrared CO₂ sensor replaces the traditional incandescent IR light source with silicon MEMS emitter technology that improves stability and reliable service life. This sensor is ideal for labs looking for the best of both technologies for advanced, high volume, or value culturing.

- Internal auto-calibration eliminates drift due to changes in ambient conditions that can affect traditional IR sensors
- IR180Si CO₂ measurement not affected by changes in temperature, humidity, oxygen, or barometric pressure**
- Highly responsive with recovery under 5 minutes from door openings

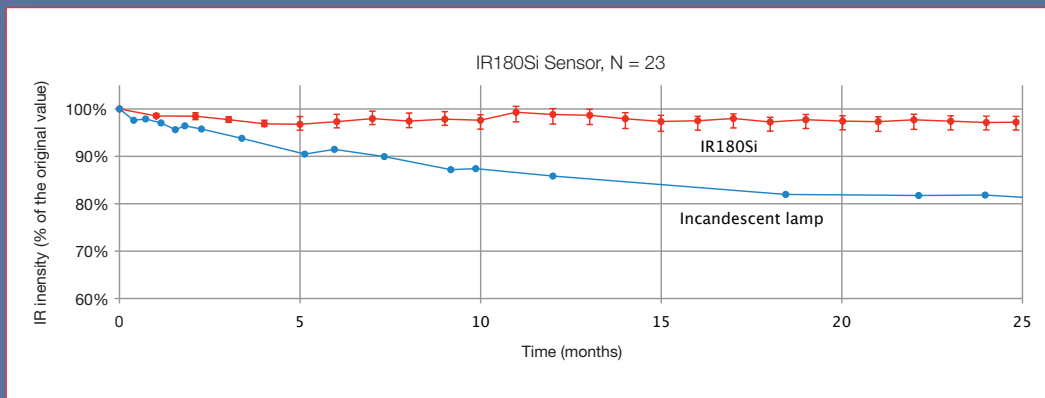

A traditional IR sensor contains an incandescent bulb that puts out less light as it ages, resulting in sensor drift. The IR180Si eliminates this problem. Our silicon MEMS emitter is designed to retain intensity over time, lasting up to 50% longer than ordinary IR sensors.

Innovative TC sensor solution

The NEW TC180 offers the performance advantages of traditional IR technologies without the limiting lifespan of a standard incandescent bulb. This sensor is ideal for everyday cell culture applications.

- Improved stability with internal humidity compensation minimizing drift between calibrations
- CO₂ values unaffected by changes in humidity, enabling fast recovery from a routine door opening
- Economical, long service life

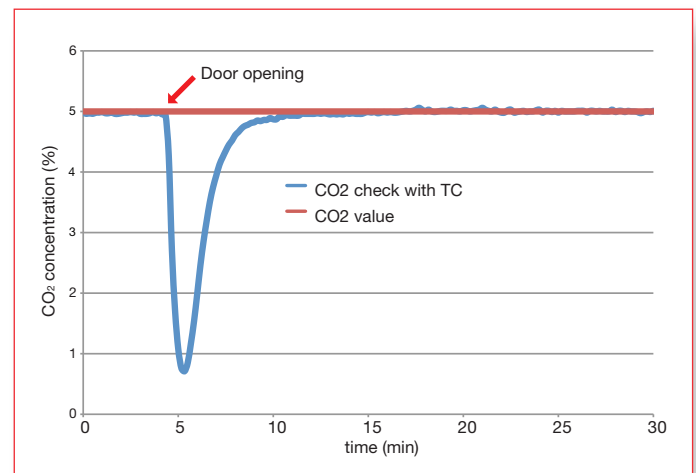

TC180 – CO₂ recovery under 6 minutes from a door opening of 30 seconds.

*CO₂ recovery time calculated to 98% of starting value, based on internal testing standards of a 30 second door opening

**Information cited based on sensor manufacturer's data

Added culturing flexibility with variable oxygen control

Many cell types thrive best in CO₂ incubators with reduced oxygen. Culturing cells at lower oxygen concentration will better simulate physiological conditions, resulting in cell behaviors that are more predictive of the *in vivo* environment.

Our variable oxygen control (or “tri-gas”) incubators will generate conditions to help your cells grow faster and healthier. With the Heracell VIOS incubator, you can select the incubator for your O₂ range: simulate hypoxic (1-21%) environments for primary cell, stem cell and embryo research applications, or hyperoxic (5-90%) conditions for research in lung, retina and other sensitive tissues.

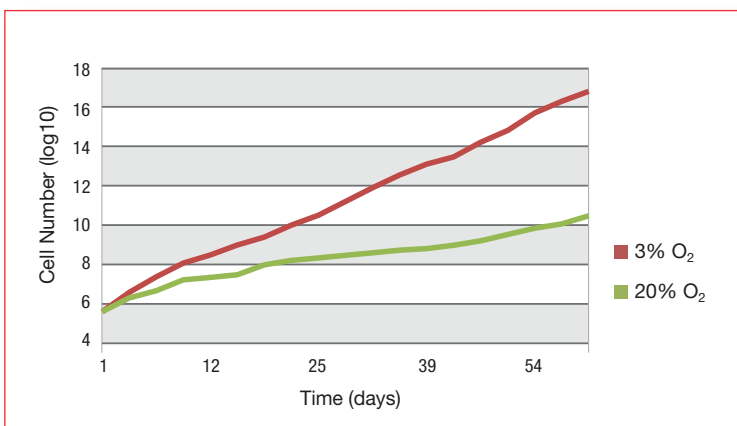

Primary Cell Growth in Atmospheric and Physiological Oxygen

Cells cultured in low oxygen (hypoxia) will generally grow faster, live longer, and show lower stress.

Adapted from Parrinello et al. Nature Cell Biology 2003.

With segmented inner doors, accessing separate sections of the incubator is convenient, minimizing recovery time and contamination risk.

"Our lab mandates this [5% oxygen in the tri-gas incubator] in order to mimic conditions in the body, so that cells are as close to those conditions as possible and nothing is different. All of the signals for proper epigenetics are there."

Stem cell researcher at biomedical research institute



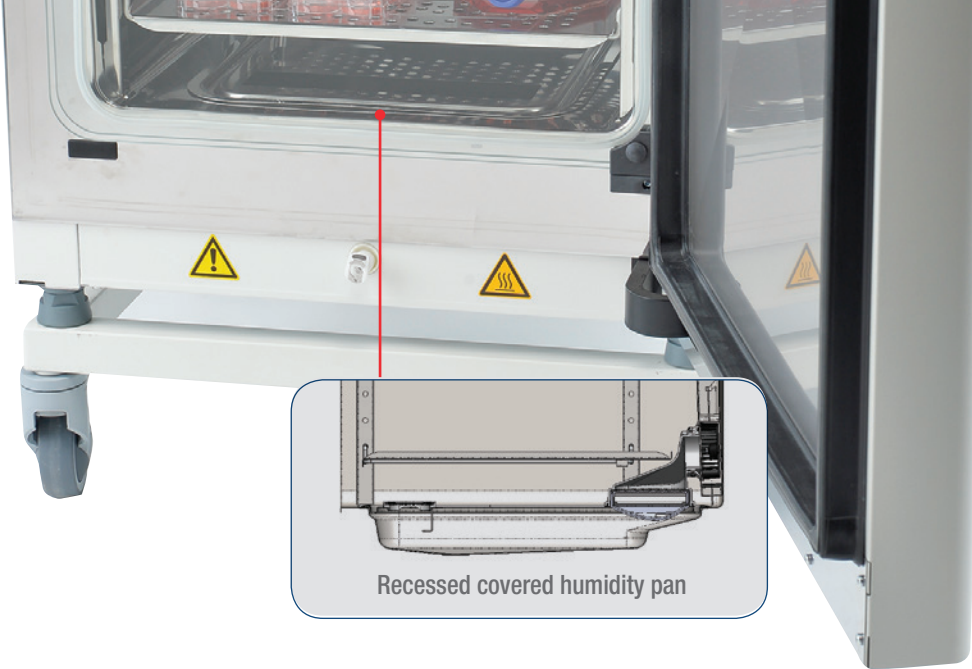

Recessed covered humidity pan

Exclusive condensation free humidification system

Our unique integral covered humidity reservoir maximizes relative humidity without condensation ensuring a dry inner chamber, preventing a breeding ground for contaminants.

- Providing stable, high relative humidity levels, the integrated 3 liter reservoir allows more space for samples than standard pan designs
- The reservoir cover eliminates standing water in the culture area while limiting particles and spilled media from settling into the reservoir
- Water level is continuously monitored and displayed on the Thermo Scientific iCAN™ touchscreen with advanced notice of refill needed
- Humidity reservoir may be filled without removing shelves or cultures and is easily drained through built-in copper drain
- CO₂ and optional N₂/O₂ gases are pre-humidified before entering the chamber, providing a more constant, uniform environment

Evaporation is 4X faster at 80% than at > 93% humidity*. Maximum humidity with rapid recovery is critical to limit water evaporation from media that results in toxic concentrations.

*Esser, P and Weitzmann, L. Evaporation From Cell Culture Plates. Thermo Scientific 2011, TILSPNUNCBU02 0111

Directly heated reservoir boosts 5X faster recovery than removable pan designs.

Relative humidity recovery is less than 10 minutes with 30 second door opening.**

**Humidity recovery time calculated to 95% of starting value, based on internal testing standards of a 30 second door opening.

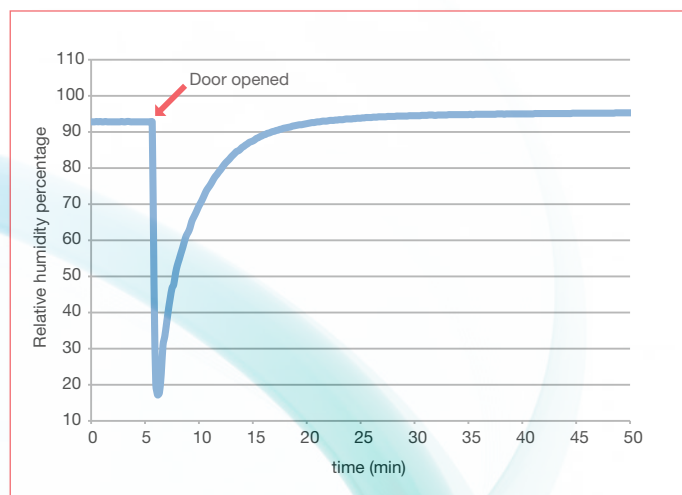

Complete **contamination control**

Protect your cultures with proven technologies

Our advanced contamination control technologies are designed to protect your valuable cultures, eliminate the loss of time and resources while providing convenient added security for your research work.

“Normal” indoor air contains 30-700 microorganisms/m³.^{*}
Normal flora on our skin equals 10,000 microorganism/cm².^{**} These can enter your incubator during routine door openings.

Heracell VIOS incubators deliver the latest innovations in contamination control technologies that protect the incubator air, surfaces and humidification water. Cultures are continuously protected 24/7, and convenient on-demand high temperature sterilization offers simplified cleaning protocols.

^{*} Stryjakowska-Sekulska et al. 2007.

^{**} Grice et al. 2008

▶ Expand the growth of even your most finicky cells with specialty coated Thermo Scientific™ EasYFlasks™, featuring a unique angled neck for full access to the growth surface when pipetting.

www.thermoscientific.com/easyflasks



High-temperature sterilization with push button simplicity

Our exclusive Thermo Scientific Steri-Run™ high temperature sterilization cycle reaches 180°C on all chamber surfaces and is independently proven to achieve total sterilization and a 12 log Sterility Assurance Level (SAL). With the push of a button, the simple overnight routine provides fast, easy elimination of microbial contaminants and eliminates the need for separate autoclaving of parts.

- Fully automatic 180°C cycle assures total, uniform sterilization of all chamber surfaces (12 log SAL)
- Independent third party tests prove elimination of biological contaminants including fungal mold, vegetative and spore forms of bacteria, including mycoplasma
- Avoids the physical constraints and variation associated with UV germicidal lamps and the ongoing costs, handling and storage of potentially toxic germicides

The U.S. and E.U. Pharmacopeias no longer recommend a given temperature and time for sterilization. Instead, they require proof of performance. To meet requirements of a 12 log SAL, a 6 log reduction of biological indicator endospores must be demonstrated in half the time.

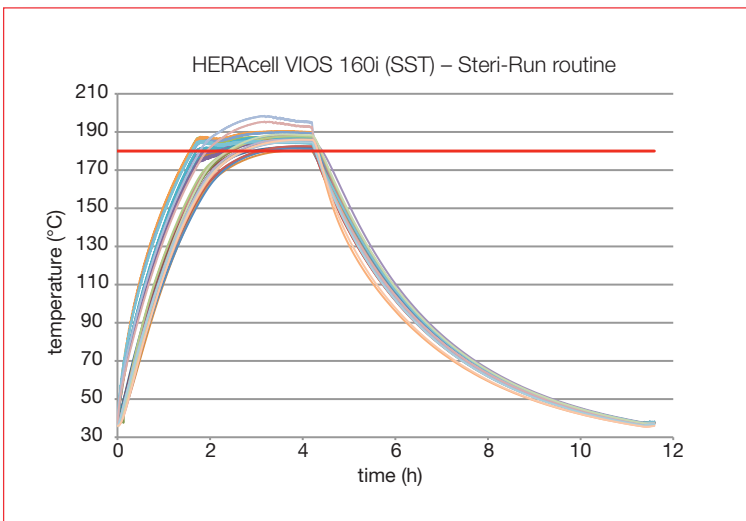

Validation that all surfaces reach 180°C with 47 point test on all chamber areas including the glass door and shelves.

Microorganisms Eliminated During the Steri-Run cycle*

Microorganism	ATCC #	Average Positive Control*	Number Recovered*	Log Reduction*
<i>Aspergillus brasiliensis</i>	16404	2.98x10 ⁴	NG**	-4.5
<i>Escherichia coli</i>	25922	2.22x10 ⁴	NG	-4.3
<i>Mycoplasma pneumoniae</i>	15531	1.25x10 ⁶	NG	-6.1
<i>Bacillus atrophaeus</i> spores	51189	2.16x10 ⁷	NG	-7.3
<i>Geobacillus stearothermophilus</i> spores	12980	4.81x10 ⁶	NG	-6.7

*Average based on 3 independent tests performed on different days.

** NG = No Growth

Independent third party testing proved the Steri-Run cycle, when heated to 180°C for 45 minutes, eliminated all microorganisms – validating that the full 90-minute cycle meets requirements for a >12 log sterility assurance level (SAL).

HEPA Air Filtration for Air Purity

Airborne particulates are a primary source of contamination in most lab settings. Our advanced HEPA filter technology protects your cultures, providing Class ISO-5 clean room-like air quality conditions within only five minutes after a 30-second door opening.

- Chamber air is processed every 60 seconds to ensure air quality
- Featuring a space saving configuration, the HEPA filter is readily replaceable with minimal cost

HEPA filters are rated for their efficiency of capturing 0.3 μm sized particles, since this is the most penetrating size. In fact, larger and smaller particles are caught even more efficiently, over 99.998%

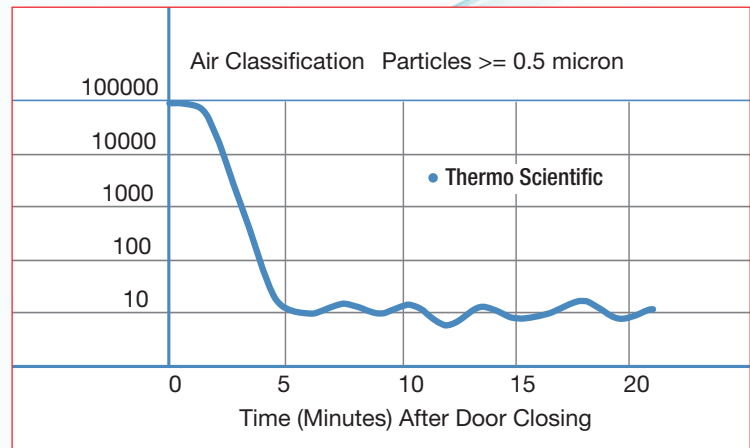

Security for your cells. The HEPA filter provides a 4 log reduction of particles in 5 minutes. ISO 5 clean room air quality achieved in 5 minutes from a door opening.

| easy to maintain

Easy to maintain 100% solid copper

More cell culture professionals are choosing Thermo Scientific incubators with 100% pure copper interiors.

- Easy-to-clean, no special handling required
- Corrosion resistant copper surfaces provide long service life and are safe for cultured cells
- Durability, reliability, and recyclability makes copper a smart, sustainable choice

“Everything we do is cell based. The main thing I’ve noticed is my ability to maintain my cells. There is just no comparison since we got the copper. I’ve had stainless steel incubators before but the comfort level you can have with the copper is simply amazing.”

Laboratory Manager with 14 years experience working with all types of mammalian cell lines, including adherent, suspension, hybridomas and transformed stem cells

Enhanced Simplicity

The Heracell VIOS series was designed to simplify your interaction with the incubator. Spend more time pursuing your science and less time managing your equipment.

Main screen with a bright LED display provides at-a-glance monitoring even from a distance.

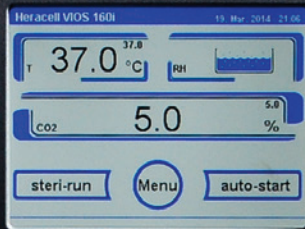

iCAN™ Touchscreen Interface

Total control at your fingertips

The intelligent iCAN interface provides complete data visibility to monitor all incubator interaction, featuring door-mounted position for easy access, on-screen menu prompts, error and usage logs, data logging, performance trend graphing and multiple language selection.

New rH monitoring assures the proper humidity level with blue, full line icon. Low water alarm indicates critical low humidity levels requiring water addition.

ISO 5 icon indicates the chamber has reached clean room air quality, protecting your cultures.

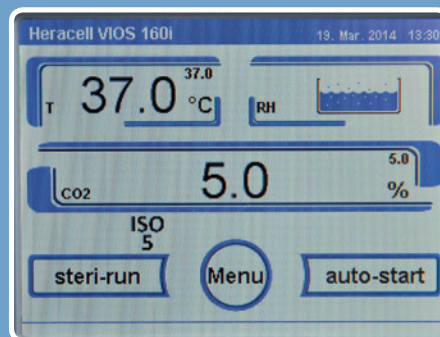

Loop	Date	Time	Error	001/002
RH	25.02.14	09:28:06	No water	
RH	24.02.14	16:07:55	No water	
SYS	24.02.14	15:38:18	Error fan	
SYS	24.02.14	15:33:48	Error fan	
RH	24.02.14	15:32:49	No water	
SYS	24.02.14	14:41:33	Error fan	
SYS	18.02.14	08:20:54	Error fan	
SYS	17.02.14	14:42:48	Error fan	
SYS	17.02.14	14:08:24	Error fan	
SYS	17.02.14	13:59:27	Error fan	
SYS	10.02.14	16:46:48	Error auto-start	

▲ **On-demand data and error logs** provide a downloadable history of activity and conditions including parameter changes and alarms.



Optimized chamber design for easy maintenance and monitoring

- Conveniently manage reminders for HEPA filter, Steri-Run sterilization cycle and Autostart automatic calibration functions
- Programmable access code ensures additional security of your settings and information
- Selectable languages simplify operation: English, Spanish, German, French, Italian, Japanese and Mandarin
- For easier water handling, humidity reservoir may be filled or drained without the removal of shelves or cultures
- Easy-to-clean, covered corners with convenient access port
- No special tools required for assembly and disassembly of interior components



Data collection

Retire your laboratory notebook, data collection is easy with a Heracell VIOS incubator. A data collection software disc is supplied with each unit, to facilitate data capture from the unit's convenient rear mounted USB output port.

Optional 4-20 mA signal output is available for interfacing with external data collection systems, such as Thermo Scientific™ Smart Vue™ remote monitoring system which is ideal for GMP environments with external sensors and CFR-21 compliant software packages.

construction	Chamber volume	165L (5.8 cu.ft.)
	Interior chamber	electropolished stainless steel or 100% solid copper
	Exterior chamber	18 gauge (1 mm), cold-rolled steel, powder coated
	Access port	42 mm diameter
	Data outputs	remote alarm contacts, USB, and optional 4-20 mA
dimensions	Internal dimensions (w x h x d)	470 x 607 x 576 mm
		18.5 x 23.9 x 22.7 inches
	External dimensions (w x h x d)	637 x 900 x 880 mm
		25.1 x 35.4 x 34.6 inches
	Shipping dimensions (w x h x d)	755 x 1010 x 1205 mm
	Operating weight	83 kg (without accessories), (183 lbs)
Shipping weight	98 kg, (216 lbs)	
shelves	Dimensions (w x d)	423 x 465 mm (16.7 x 18.3 in)
	Number standard/maximum	3/10
	Max. load per shelf/total load	10/30 kg (22/66 lbs)
	Construction	perforated, adjustable
electrical	Rated voltage	1/N/PE AC (\pm 10%), 230, 220V, 120V, 100V
	Nominal kW consumption (Steri-Run)	0.56 (1.06) – 230V, 0.51 (0.97) – 220V
		0.55 (1.01) - 120V, 0.39 (0.72) – 100V
	Rated frequency	50/60 Hz
	Heat emission to environment at 37°C	0.06 kWh/h
During Steri-Run:	0.26 kWh/h (average), 0.78 kWh/h (heating time), 0.59 kWh/h (hold time)	
temperature	Control	\pm 0.1°C
	Range	Range 3°C above ambient to 55°C
	Uniformity	< \pm 0.3°C
	Ambient range	18...34°C
	Tracking alarm	\pm 1°C
sterilization cycle	Cycle temperature	180°C on all internal surfaces
	Cycle duration	Under 12 hours
humidity	RH	>93% @ 37°C
	Humidity reservoir	max. 3L / min 0.5L
CO ₂	Control	\pm 0.1%
	Range	1-20%
	Tracking alarm	\pm 1%
	Inlet pressure	12-15 PSI (0.8-1.0 bar)
	Gas purity	min. 99.5 or medical quality
	CO ₂ inlet	1/8" hose (barbed)
O ₂	Control	\pm 0.1%
	Range	1-21% or 5-90%
	Tracking alarm	\pm 1%
	Inlet pressure	12-15 PSI (0.8-1.0 bar)
	Gas purity	min. 99.5 or med. quality
	O ₂ inlet	1/8" hose (barbed)

Select the Heracell VIOS incubator that best meets your culturing needs

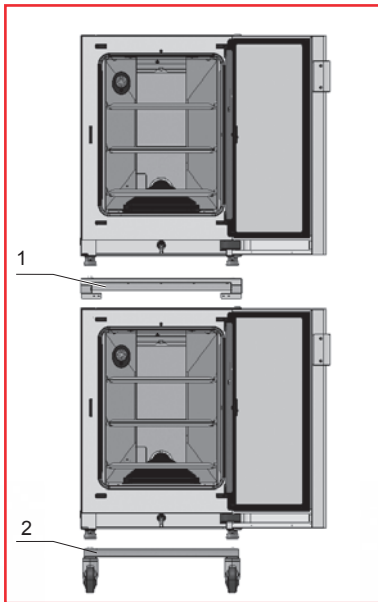

Units are easily stackable. Required stacking adapter provides efficient heat dissipation to operate Steri-Run in one unit while culturing in the other without process disruption.

Heracell VIOS 160i CO ₂ Incubator		Stainless Steel		100% Copper	
		Thermo Scientific Cat. No.	Fisher Scientific Cat. No.	Thermo Scientific Cat. No.	Fisher Scientific Cat. No.
Preconfigured CO ₂ Incubator Packages	Single chamber with TC CO ₂ sensor, 120V 50/60Hz (Base model)	51030285	13998211	51030284	13998212
	Single chamber with IR CO ₂ sensor, 120V 50/60Hz	51030400	13998130	51030401	13998131
	Dual chamber with TC CO ₂ sensor, includes stacking adapter and roller dolly, 120V 50/60Hz	50144906	13998223	50144908	13998224
	Dual chamber with IR CO ₂ sensor, includes stacking adapter and roller dolly, 120V 50/60Hz	50145504	13998142	50145516	13998143
	Tri-gas single chamber with TC CO ₂ sensor, 1-21% O ₂ control, 120V 50/60Hz	51030403	13998213	51030408	13998215
	Tri-gas single chamber with IR CO ₂ sensor, 1-21% O ₂ control, 120V 50/60Hz	51030405	13998132	51030410	13998134

Options and accessories to customize your Heracell VIOS CO₂ incubators

	Thermo Scientific Cat. No.	Fisher Scientific Cat. No.	
Stacking and Roller Dolly Customer Installed	50145394	13998147	Support frame for double chamber, 172 mm high (with casters)
	50145435	13998148	Support frame for double chamber, 200 mm high (without casters)
	50145436	13998149	Support frame for single chamber, 780 mm high (without casters)
	50144550	13998150	Adaptor required for stacking 160L models
	50145437	13998151	Stacking adaptor configured to stack a Heracell VIOS on top of Heracell 150i
	50051909	13998061	Additional stainless steel shelf, full-width, 2 support rails
	50051910	13998062	Additional shelf, solid copper, full-width, with 2 support rails
	50051913	11688010	Set of 3 HERAtrays 1/3 width in stainless steel (autoclaveable)
	50051914	11688011	Set of 3 HERAtrays 1/3 width in solid copper
	50058672	11688012	Set of 2 HERAtrays, 1/2 width, in stainless steel (autoclaveable)
	50061050	11688013	Set of 2 HERAtrays, 1/2 width, in copper
	50141920	13998152	Replacement in chamber HEPA filter
	95001012	13998069	CO ₂ gas regulator, 2-stage, for gas tank
	95001013	13998070	N ₂ gas regulator, 2-stage for gas tank
	95001014	13998071	O ₂ gas regulator, 2-stage for gas tank
	50059043	13998072	External gas tank monitor GM 2, automatic change-over to reserve tank, 120 V, 50/60 Hz, with visual-acoustic signal, central monitoring connection; for wall or table installation
	50121515	13998198	IR gas tester with travel case (for advanced calibration and testing purposes)
	50122015	13998199	IR gas tester interface kit (Windows Vista and XP compatible)

Please contact your Thermo Fisher Scientific sales representative for assistance configuring and ordering an incubator with these options.

Factory Installed Options Order with base model 13998211 and 13998212	51901143	Internal 4-20 mA analog data output
	51900293	Left hinge door configuration
	51900735	Internal gas guard for CO ₂
	51900736	Internal gas guard for N ₂ /O ₂
	51901126	Stainless steel external outer casing
	51901144	3 door inner gas tight screen (replaces single inner door configuration)
	51901137	1-21% O ₂ control
	51901138	5-90% O ₂ control
	51901145	1-21% O ₂ control with 3 door inner gas tight screen door
	51901146	5-90% O ₂ control with 3 door inner gas tight screen door

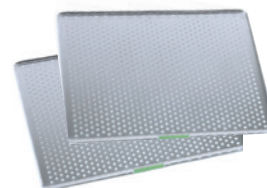



thermoscientific.com/co2

© 2015 Thermo Fisher Scientific Inc. All rights reserved. All trademarks are the property of Thermo Fisher Scientific and its subsidiaries.



In the United States:

For customer service, call 1-800-640-0640

To fax an order, use 1-800-290-0290

To order online: www.fisherhealthcare.com

Thermo
SCIENTIFIC

A Thermo Fisher Scientific Brand